

G2102 C CONVECTION OVEN RANGE G2112 C & G2112 C/2 CONVECTION OVENS



INSTALLATION and SERVICING INSTRUCTIONS

These appliances must be installed and serviced by a competent person as stipulated by the Gas Safety (Installation & Use) Regulations.

IMPORTANT

The installer must ensure that the installation of the appliance is in conformity with these instructions and National Regulations in force at the time of installation. Particular attention **MUST** be paid to –

BS7671 I.E.E. Wiring Regulations
Electricity At Work Regulations
Gas Safety (Installation & Use) Regulations

Health And Safety At Work etc. Act
Local and National Building Regulations
Fire Precautions Act

Detailed recommendations are contained in
Institute
Of Gas Engineers published documents:
IGE/ UP/ 1, IGE/ UP/ 2
BS6173 and BS5440

The appliances have been CE-marked on the basis of compliance with the Gas Appliance Directive, EMC and Low Voltage Directive for the Countries, Gas Types, Gas Pressures and voltages as stated on the Data Plate.

WARNING - TO PREVENT SHOCKS, ALL APPLIANCES MUST BE EARTHED

On completion of the installation, these instructions should be left with the Engineer-in-Charge for reference during servicing. Further to this, The Users Instructions should be handed over to the User, having had a demonstration of the operation and cleaning of the appliance.

IT IS MOST IMPORTANT THAT THESE INSTRUCTIONS BE CONSULTED BEFORE INSTALLING AND COMMISSIONING THIS APPLIANCE. FAILURE TO COMPLY WITH THE SPECIFIED PROCEDURES MAY RESULT IN DAMAGE OR THE NEED FOR A SERVICE CALL.

PREVENTATIVE MAINTENANCE CONTRACT

In order to obtain maximum performance from this unit we would recommend that a Maintenance Contract be arranged with SERVICELINE. Visits may then be made at agreed intervals to carry out adjustments and repairs. A quotation will be given upon request to the contact numbers below.



WEEE Directive Registration No. WEE/DC0059TT/PRO

At end of unit life, dispose of appliance and any replacement parts in a safe manner, via a licensed waste handler.
Units are designed to be dismantled easily and recycling of all material is encouraged whenever practicable.

Falcon Foodservice Equipment

Head Office and Works
Wallace View, Hillfoots Road, Stirling, FK9 5PY, Scotland.

Serviceline
PHONE: 01438 363 000

T100970 Ref.2

Warranty Policy Shortlist

Warranty does not cover:-

Correcting faults caused by incorrect installation of a product.

Where an engineer cannot gain access to a site or a product.

Repeat commission visits.

Replacement of any parts where damage has been caused by misuse.

Engineer waiting time will be chargeable.

Routine maintenance and cleaning.

Gas conversions i.e. Natural to Propane gas.

Descaling of water products and cleaning of water sensors where softeners/conditioners are not fitted, or are fitted and not maintained.

Blocked drains.

Independent steam generation systems.

Gas, water and electrical supply external to unit.

Light bulbs.

Re-installing vacuum in kettle jackets.

Replacement of grill burner ceramics when damage has been clearly caused by misuse.

Where an engineer finds no fault with a product that has been reported faulty.

Re-setting or adjustment of thermostats when unit is operating to specification.

Cleaning and unblocking of fryer filter systems due to customer misuse.

Lubrication and adjustment of door catches.

Cleaning and Maintenance

- Cleaning of burner jets

- Poor combustion caused by lack of cleaning

- Lubrication of moving parts

- Lubrication of gas cocks

- Cleaning/adjustment of pilots

- Correction of gas pressure to appliance.

- Renewing of electric cable ends.

- Replacement of fuses

- Corrosion caused by use of chemical cleaners.

SECTION 1 – INSTALLATION

Important: Check that no damage has occurred to the appliance or power cable during transit.

If damage has occurred do not install/use the appliance.

Installation, periodic testing, repair and fixed wiring connections should only be undertaken by a competent electrician.

Ensure that the mains power cable is routed free from the appliance to avoid damage.

We recommend supplementary electrical protection with the use of a residual current device.

Take care when removing or replacing cast iron components as they are heavy items.

Pan Support - 5kg

UNLESS OTHERWISE STATED, PARTS WHICH HAVE BEEN PROTECTED BY THE MANUFACTURER ARE NOT TO BE ADJUSTED BY THE INSTALLER.

1.1 MODEL NUMBERS, NETT WEIGHTS and DIMENSIONS

MODEL	WIDTH mm	DEPTH mm	HEIGHT mm	WEIGHT kg
G2102 C RANGE	900	770	870	221
G2112 C OVEN ON STAND	900	770	1310	190
G2112 C/2 DOUBLE TIER OVEN	900	770	1465	362

1.2 SITING

All units, other than G2112 C oven on stand, must be installed on a non-combustible floor. All units must be situated on a level surface. Although the appliance feet are adjustable to facilitate levelling, the adjustment range is limited.

A clearance of at least 150mm must be allowed from any combustible wall.

If practicable, it is recommended that a space of at least 400mm be allowed from any side wall to provide clearance for adjusting the rear levelling bolts, and to effect the removal of the RH side panel to facilitate servicing.

A vertical clearance of 1200mm minimum must be allowed between the top edge of flue outlet and any overlying combustible surface.

If unit is being installed as part of a suite, it is also recommended that it be positioned at the RH end to provide unrestricted access for servicing the controls, etc. Furthermore, if installed in a suite, either central or adjacent to a wall, with a boxed-in void at the rear, it is vitally important that the void be adequately ventilated to ensure a supply of air to the motor cooling fan at the rear of the oven.

Important

Care must be taken not to disturb the air for combustion admission and evacuation of products of combustion on appliances fitted with open burners.

1.3 VENTILATION

This appliance must be installed in a suitably ventilated room in accordance with the regulations in force.

Adequate ventilation, whether natural or mechanical, must be provided to ensure sufficient fresh air for combustion and for removal of combustion and cooking vapours.

The fresh air requirement for this appliance at a rate of 3M³/hour per kW is 150M³ of fresh air per hour.

This appliance is to be installed with sufficient ventilation to prevent the occurrence of unacceptable concentrations of substances harmful to health in the room which they are installed.

The appliance flue discharges vertically at the rear. There must be no direct connection of the flue to outside air or to a mechanical extraction system. Standing the appliance below a ventilated canopy is the most suitable arrangement.

Recommendations for ventilation for catering appliances are given in BS 5440:2.

For multiple installations, the requirements should be added together. Installation should be made in accordance with local and/or national regulations applying at the time, and a competent installer must be employed.

Care must be taken not to disturb the air for combustion admission and evacuation of products of combustion on appliances fitted with open burners.

1.4 GAS SUPPLY

The incoming service must be of sufficient size to supply full rate without excessive pressure drop. A gas meter is connected to the service pipe by the Gas Supplier. Any existing meter should be checked by the Gas Supplier to ensure the meter is of adequate capacity to pass the required rate of gas.

Installation pipe work should be fitted in accordance with IGE/UP/2. The pipe should be of adequate size but not smaller than the gas inlet.

Gas supply tubing or hose shall comply with the national requirements in force, and shall be periodically examined and replaced as necessary. The tubing or Flexible hose must not exceed 1.5m in length.

Connections are as follows:

G2102 C Range:

Rp3/4^ø (3/4" BSP female)

G2112 C Oven:

Rp1/2 (1/2" BSP female)

An isolating cock must be located close to the appliance to allow shut-down during an emergency or servicing. The installation must be tested for gas soundness and purged as specified in IGE/UP/1.

The position of the isolating cock must be made known to the user of the equipment and/or supervisor.

The isolating cock must be easily accessible to the users of the appliance.

Note

The G2102 C open top range is supplied complete with the necessary pipework for linking oven and open top burner sections. The governor necessary for open top burners is incorporated in this pipework for Natural Gas operation. The oven control valve incorporates a governor for the oven and an extra governor must not be fitted to any of these appliances and an extra governor must not be fitted to any of these appliances.

1.5 ELECTRICAL SUPPLY

Installation, periodic testing, repair and fixed wiring connections should only be undertaken by a competent electrician.

The oven is equipped with a length of 3-core flexible cord for connecting to an electrical supply. A standard 13 amp socket outlet can be used, in which case the plug must be fitted with a 3 amp fuse. If the supply is through a distribution fuse box, it must be via a fuse having a maximum rating of 5 amps.

We recommend supplementary electrical protection with the use of a residual current device (RCD).

1.6 WATER SUPPLY

Not applicable to these appliances.

1.7 TOTAL GAS RATES -

Natural I₂H and Propane Gas I₃P

Model	kW (net)	Btu/hr (gross)
G2102 C	49.8	187,000
G2112 C	18	67,600
G2112 C/2	36	135,100

1.7.1 Individual Burner Ratings -

Natural I₂H and Propane Gas I₃P

Burner type	kW (net)	Btu/hr (gross)
Open Top (x6)	5.3	20,000
Oven	18	67,600
Oven Pilot/ignition	0.25	940

1.8 INJECTOR DIAMETERS - Natural I₂H & Propane Gas I₃P

	Natural Gas I ₂ H	Propane Gas I ₃ P
Open top	Ø1.92mm	Ø1.2mm
Oven	Ø3.3mm	Ø2.2mm
Oven Pilot	G29.2	G24.1

1.9 GAS PRESSURE

	Supply Pressure		Burner Operating Pressure	
	Nat I ₂ H	Prop I ₃ P	Nat I ₂ H	Prop I ₃ P
mbar	20	37	15	37

1.10 BURNER ADJUSTMENTS

1.10.1 Burner Aeration

All burners have fixed aeration, and no modifications to the size of air-entry should be attempted.

1.10.2 Open Top Gas Tap – Low Position Screw Details

The Open Top Low Position flow to burner is governed by the size of the fixed hole in Low Position Screw as detailed below: - The screw is located to Right hand side of the gas tap spindle.

Turndown Flow	1.1kW
Natural Gas I₂H	No.76
Propane Gas I₃P	No.51

1.11 FAN UNIT

This fan has two impellers, directly mounted on the motor shaft. The main impeller is inside the oven, its purpose being to circulate air across the heat-exchangers and around the cooking space, while a smaller, externally mounted impeller serves to cool the motor and control compartment. The fan turns anticlockwise when viewed from inside the oven chamber.

SECTION 2 - ASSEMBLY and COMMISSIONING

2.1 ASSEMBLY

2.1.1 G2102 C Open Top Range

Important: Before installation, ensure that no damage has occurred to the appliance or flexible power cord.

If there are signs of damage, DO NOT INSTALL THE APPLIANCE.

Installation, periodic testing, repair and fixed wiring connections should only be undertaken by a competent electrician.

- a) Unpack unit, open oven doors and remove inter-connecting pipework (and governor on natural gas appliances) from inside.
- b) Fit interconnecting pipework, leaving incoming pipe entry facing in desired direction to suit service pipe.
- c) Place unit into desired location, if necessary adjust levelling bolts. Access to these, at front, is gained upon removing burner grille below oven doors. The rear bolts are accessible via openings in outer back panel. Do not raise unit more than is absolutely necessary to effect levelling.
- d) Connect gas supply and test for gas soundness.
- e) Connect electrical supply ensuring flexible cord does not make contact with flue or other hot areas.

The wires of flexible cord must be connected to supply as follows:

Brown to Live

Blue to Neutral

Green/Yellow to Earth

This appliance MUST be earthed.

We recommend supplementary electrical protection with the use of a residual current device (RCD).

2.1.2 G2112 C Oven on Legs

Installation procedure is as Section 2.1.1, but omits (b) and for (c) it is not necessary to remove lower front panel. Levelling is effected by turning lower parts of the feet.

2.1.3 G2112 C Oven on Stand

Installation procedure is as follows:

- a) Unpack oven and stand that is packed separately in a dismantled state.
- b) Assemble stand (see Figure 1) using the following procedure:
 1. Position bottom shelf (A) over frame (B) and secure stand legs (C) to frame (B) using M8 fixings to secure from below.
 2. Fit adjustable legs (D) to frame (B) using M6 fixings provided.
 3. Using pliers or a similar tool, bend and remove tabs from front brackets.

4. Lift oven carefully upon stand and ensure mounting brackets are secured to oven base, lined up with the leg top brackets. Secure oven to stand using M6 fixings through holes indicated in Figure 1.
5. Manoeuvre oven and stand into desired location and level by turning lower part of the feet.
6. Connect to gas and electrical supplies as detailed in Sections 1.4 and 1.5.

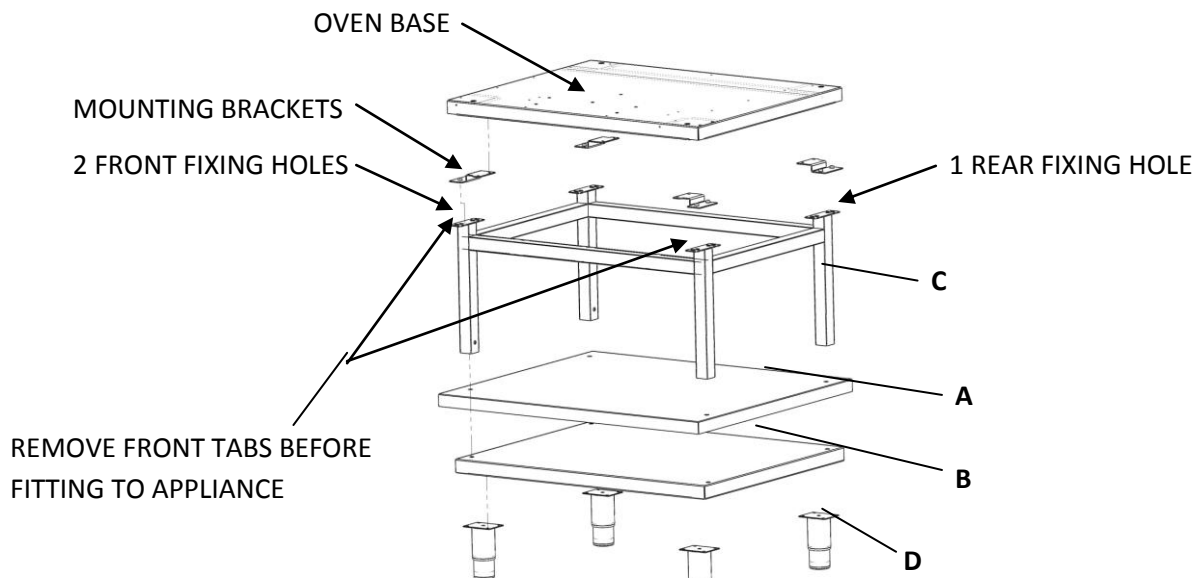

Figure 1

2.1.4 G2112 C/2 Two Tier Oven (See Figure 2)

These units are marked as TOP and BOTTOM ovens before leaving the factory. The top unit is identified by having a worktop on top.

Installation procedure is as follows:

- a) Place lower oven in approximate final location.
- b) Remove bottom grille on upper oven. To effect removal, slacken grille fixings beneath oven doors. Remove control panel and grille base fixings.
- c) Lift top unit onto lower unit, taking care not to damage upturned flange at rear of lower unit. Align back edge of top unit carefully against back flange.
- d) Secure top unit to lower unit using M6 x 50mm fixings provided. (Two at base front corners and two at rear through rectangular openings in lower corners of outer back panel).
- e) Fit pipework supplied for interconnecting the two individual gas inlets.
- f) Manoeuvre double unit into final position and carefully level by adjusting levelling bolts in bottom oven base. Do not adjust more than is necessary to effect a true level.
- g) Connect to gas and electrical supplies as detailed in Sections 1.4 and 1.5.

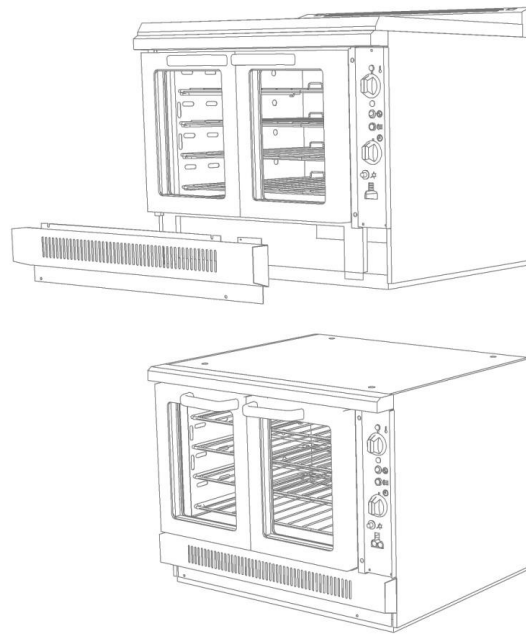

Figure 2

2.1.5 Assembly of Splash Plate and Plate Shelf (G2102 C Only)

Fit as per instructions supplied with kit.

2.2 CONNECTION TO A GAS SUPPLY

The gas supply piping and connection to unit must be installed in accordance with the various regulations listed on front page of this document. Refer further to Section 1.4 and check gas soundness.

2.3 CONNECTION TO AN ELECTRICAL SUPPLY

The electrical connections must comply with relevant standards listed on the front page of this document. Refer further to Section 1.5.

2.4 CONNECTION TO A WATER SUPPLY

Not applicable to these appliances.

2.5 PRE-COMMISSIONING CHECK and Pressure checking/setting (Natural gas appliances only).

Ensure lift-off hob with open-top burners (where applicable) or worktop and oven linings are properly located. Check also that oven grid shelves slide in and out easily. Check all packing material has been removed.

Check electric power cord is satisfactorily routed and not in contact with the appliance.

Important: It is necessary for gas pressure to be checked before the unit is commissioned. A suitable pressure gauge must be connected to pressure test point(s) as follows:

2.5.1 Open Top Burners (where applicable).

Pull gas tap knobs off and remove control panel to access test point. Refer to Section 1.9 for pressure settings. Three burners should be operating on full flame when setting burner operating pressure.

The open top burner gas pressure is adjusted by means of external governor mounted at rear of unit.

2.5.2 Ovens

FIRST ENSURE ELECTRICITY SUPPLY TO APPLIANCE IS OFF.

Remove oven control panel as detailed in Section 3.2.1 and draw panel forward on its slides. Remove burner grille (4 screws).

Connect pressure gauge to outlet test point immediately below multifunctional gas control.

Note that inlet and outlet points are provided on multifunctional control also.

- a) Slide oven control panel back into position and re-establish electricity supply.
- b) Light oven as described in accompanying User's Instructions.

Note: If the pilot can be established but the main burner will not light – check if the safety thermostat has tripped.

- c) Oven burner is controlled by a two stage multifunctional control. Pressure should pause for a brief period at an intermediate level (oven ignition pressure) before attaining full burner operating pressure.

Refer to Section 1.9 for maximum operating pressure setting.

- d) Adjust pressure on Natural gas models by turning governor on multifunctional control, anti-clockwise to decrease pressure and clockwise to increase pressure. (See Figure 3).
- e) Propane models have a governor override screw fitted and are not adjustable.
- f) Extinguish main burner and Pilot by turning burner control knob on multifunctional control valve to OFF Position and turn off electricity supply at mains. Replace test point screws, control panels etc.

2.5.3 Checking Performance Of The Controls

When satisfied that pressures are set correctly in accordance with Sections 2.5.1 and 2.5.2. Proceed as follows:

Oven

- a) Light oven as detailed in User Instructions. Set thermostat at 250°C and allow oven to heat up, ensuring fan is operating and turning anti-clockwise when viewed from front.
- b) Turn thermostat down to lowest setting and check oven burner goes out leaving pilot burner lit.
- c) Turn thermostat knob to a high setting whereupon oven burner should re-light smoothly with little or no delay.
- d) Check fan stops and that oven burner goes out when oven doors are opened.
- e) Check operation of power switch. When OFF, fan should stop and main burner is extinguished. Pilot burner, however, remains lit.
- f) Timer check. This does not turn off gas to oven but simply provides user with an audible signal that pre-set time has elapsed.
- g) Press oven light button, check that light operates.

Open Top

Light open top as detailed in User Instructions. Check ignition is smooth and without delay. Repeat this operation several times. Check that Flame failure is operating for each open top burner.

2.5.4 Multifunctional Gas Control - Description.

Access to control is gained upon withdrawal of control panel. Refer to Section 3.2.1.

This is a two stage multifunctional control for controlling the oven.

When supplied fitted in appliance, this component is factory set and should not require adjustment.

The following adjusters are available:

- a) Two test points are provided for measuring inlet and outlet pressures as detailed in Figure 3. For convenience, a further outlet pressure test point is provided in outlet immediately below control valve.
- b) Pressure adjusting governor. (Natural gas appliances only)
- c) Pilot adjusting screw. This screw is provided on the control for adjusting flow of gas to pilot burner. The unit is designed to operate on full gas flow to pilot. Turn screw clockwise to decrease flame, and anti clockwise to increase flame. Ensure that there is no gas leaking and screw remains sealed once adjusted.

Note

The gas control valve is fitted with a safety interlock. Therefore, a period of 3 minutes will elapse before it is possible to re-light after complete shut-down.

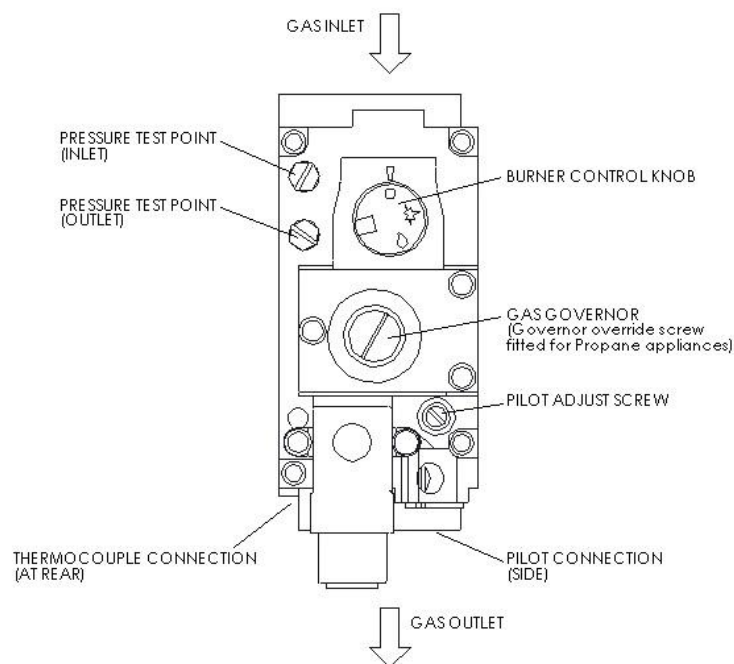

Figure 3

2.6 INSTRUCTION TO USER

Important

After installing and commissioning appliance, hand User Instructions to user or purchaser and ensure the instructions for lighting, turning off, correct use and cleaning are properly understood. The location of gas isolating cock and electrical supply switch should be made known to the user and the procedure for the operation in an emergency demonstrated.

SECTION 3 - SERVICING and CONVERSION

Important

BEFORE ATTEMPTING ANY SERVICING ENSURE THAT THE ISOLATING COCK AND MAIN ELECTRICAL SUPPLY ARE TURNED OFF AND THAT IT CANNOT BE INADVERTENTLY TURNED BACK ON.

Note

WHEN REPLACING CONNECTIONS, REFER TO WIRING DIAGRAM IN THIS MANUAL. ALL WIRES ARE NUMBERED.

AFTER ANY MAINTENANCE TASK, CHECK THE APPLIANCE TO ENSURE THAT IT PERFORMS CORRECTLY AND CARRY OUT ANY NECESSARY ADJUSTMENTS AS DETAILED IN SECTION 1.

After carrying out any servicing or exchange of gas carrying components -

ALWAYS CHECK FOR GAS SOUNDNESS!

THESE APPLIANCES MUST ONLY BE CONVERTED FOR USE WITH OTHER GASES BY A QUALIFIED ENGINEER.

3.1 GAS CONVERSION CHECK LIST

For conversion to NATURAL GAS, add correct external governor for G2102 C hob and set the burner pressure on Open Top Gas Tap manifold. Refer to Section 2.5.1.

For conversion to PROPANE GAS, remove external governor from G2102 C hob gas circuit.

Other considerations -

CHANGE INJECTORS (Refer to Section 1.8)

CHANGE OPEN TOP GAS TAP LOW POSITION SCREWS (Refer to Section 1.10)

ADJUST GOVERNOR PRESSURE – NATURAL GAS MODELS ONLY (Refer to Section 2.5.2).

ATTACH GOVERNOR OVERRIDE SCREW – PROPANE MODELS ONLY.

CHANGE DATA PLATE

3.2 REMOVAL OF PANELS and COMPONENTS

3.2.1 Oven Control Panel

Access to various electrical controls, terminals etc, also piezo igniter, is gained upon withdrawal of oven control panel. Remove fixings which secure panel and draw it forward.

3.2.2 Removal of Hob Control Panel (G2102 C only)

Remove control knobs.

Open oven doors and undo fixings along top and underside of fascia.

Pull control panel forward to remove.

Replace in reverse order.

3.2.3 Removal of Hob (G2102 C only)

Remove hob pan supports, burner heads and aluminium bezels.

The hob is retained by four ball-stud fixings. Pull hob upward to access open top burner venturi/injector holders.

Replace parts in reverse order.

Ensure burner head locates correctly upon burner bezel. This is achieved when the pips and notches of the parts align to prevent burner head from rotating. Refer to Section 4 of User Instructions.

3.2.4 Removal of Oven Linings

Remove screws in bottom of oven back panel. Ease panel bottom edge forward slightly and pull down to release top location thus enabling panel to be withdrawn from oven.

Ease rear edge of RH panel slightly toward centre then pull it back to release front edge from locating pins. Repeat for LH Panel. The base panel can now be lifted out.

3.2.5 Removal of RH Outer Side Panel

Undo oven control panel fixings and slide panel forward.

Undo burner chamber grille fixings and remove.

Undo side panel fixings along front edge.

Undo side panel fixings along rear edge.

Remove panel.

3.3 GAS CONTROLS

To service gas controls, proceed as follows:

3.3.1 To Remove Oven Multifunctional Control

Remove RH outer side panel (refer to Section 3.2.5). The unit may have to be temporarily pulled forward to gain access.

Undo thermocouple securing nut and pilot supply pipe at rear and bottom of control.

Undo screw securing mains plug to control valve and remove plug.

Undo nuts on compression fittings on both inlet and outlet gas pipes.

Remove fixings securing control bracket to oven wall.

Remove fixings securing control bracket to valve.

Replace in reverse order.

When fitting a replacement control valve, transfer gas fittings and fixing bracket from old control to new.

Set adjustment of replacement valve as detailed in Section 2.5.2.

3.3.2 To Remove Open Top Gas Taps (G2102 C only)

Remove hob control panel and hob. Refer to Sections 3.2.2 and 3.2.3.

Remove thermocouple connection from FFD section of tap.

Undo brass nut of compression fitting on gas supply pipe at gas tap rear.

Undo mounting screws and gently remove tap from supply manifold.

Replace in reverse order.

3.3.3 Re-greasing Open Top Gas Taps (G2102 C only)

Note - Plugs and bodies are machined in pairs and are therefore NOT INTERCHANGEABLE.

Always clean one tap at a time.

Remove hob control panel, refer to Section 3.2.2.

Remove fixings from tap body front. Withdraw spindle and niting arrangement to allow plug to be eased out.

Clean gas tap plug with a soft rag and re-grease using an approved high temperature lubricant. Take care not to over-grease as surplus may cause blockage in the gasways.

Replace parts in correct order and check for gas soundness.

3.4 THERMOCOUPLES

3.4.1 Oven Thermocouple

To replace, undo oven control panel fixings and slide out as detailed in Section 3.2.1. Remove burner chamber grille and RH side panel (see Section 3.2.5) Undo nuts securing thermocouple at control valve and at pilot. Withdraw through hole in oven wall. When replacing a thermocouple, do not bend to less than 15mm radius, and ensure that connections are soundly made taking care not to over-tighten valve nut. (Finger tight + quarter turn).

3.4.2 Open Top Thermocouple (G2102 C only)

Remove hob as detailed in Section 3.2.3.

Remove nut securing thermocouple to burner support bracket and pull thermocouple through support bracket from underside.

Undo thermocouple connection at FFD section of gas tap and carefully remove thermocouple from hob. Repeat for all hob burners.

Replace in reverse order taking care to position tip correctly in relation to burner ports. Thermocouple tip should be 34mm above support bracket. Ensure tip does not touch burner cap when fully re-assembled.

3.5 OVEN PIEZO UNIT

The piezo unit is secured to oven control panel.

Open oven control panel as detailed in Section 3.2.1.

Remove ignition lead and undo fixing at control panel rear.

Replace in reverse order.

3.6 OVEN PILOT BURNER ASSEMBLY

Withdraw oven control panel and remove burner chamber grille.

Undo rear nuts securing pilot supply tube and thermocouple. Pilot injector will be released, take care not to lose it. Remove spark electrode lead.

Remove screws securing pilot bracket.

Remove pilot burner with mounting bracket.

If desired, pilot burner can now be dismantled from bracket by removing two fixings.

Replace in reverse order.

3.7 REMOVAL and CLEANING of BURNERS

3.7.1 Oven Burner

To Remove

Withdraw oven control panel as detailed in Section 3.2.1 and remove burner chamber grille.

Remove pilot burner assembly as detailed in Section 3.6.

From inside control chamber, release compression fitting nut on burner feed-pipe.

Remove fixings securing main burner bracket to oven base frame.

Remove burner complete with mounting bracket, slightly left to clear pipe, then remove from front.

To Clean

Remove all accumulated debris from burner by lightly brushing, afterwards shaking or blowing clean.

Replace in reverse order.

3.7.2 Open Top Burner – Injector Assembly (G2102 C only)

To Remove

Remove lift-off hob components as detailed in Section 3.2.3.

Undo gas supply pipe compression fitting and screws securing injector assembly.

Remove burner injector assembly.

Replace in reverse order.

To Clean

Detailed cleaning procedure is given in Section 4 of User Instructions.

3.8 INJECTORS

If injector requires cleaning, do so with a wooden splinter or similar non-metallic instrument. Do not broach with a drill as this might effectively increase the diameter of injector orifice.

3.8.1 Oven Injector

Remove burner as detailed in Section 3.7 then remove injector by unscrewing it from burner.

Separate injector from elbow fitting.

Replace in reverse order.

3.8.2 Open Top Injectors (G2102 C only)

Remove pan support, burner head and aluminium bezel.

Place socket down main burner body centre. Undo and carefully remove injector.

Replace in reverse order.

3.9 OPEN TOP PRESSURE GOVERNOR (G2102 C only)

The type of governor used is maintenance free. Check that blue dust cap for the vent is fitted and in good repair. This will protect the breather hole.

3.10 OVEN DOOR SWITCH

To gain access, proceed as follows:

Withdraw oven control panel.

Remove RH side panel (as Section 3.2.5).

Remove screws holding microswitch bracket and withdraw switch by moving it down and forward. Note wire location and pull off connectors.

Remove microswitch from bracket.

Replace all parts in reverse order.

Note - The trip lever bracket holes are slotted to enable switch operation to be adjusted with respect to degree of door opening. Adjust so that fan goes off when centre edge of door is open approx. 100mm. Apply a few drops of oil to trip lever bearing occasionally.

3.11 OVEN LIGHT

To replace bulb, proceed as follows:

From inside oven, undo lens fixings and remove lens.

Unscrew bulb, taking care not to let it fall down behind oven back panel.

Fit new bulb and replace lens.

The correct type of bulb must be used.

3.12 OVEN FAN

This is removed from inside oven compartment, as follows:

Remove oven grid shelves and any loose items.

Remove oven chamber back panel as detailed in Section 3.2.4.

Remove fixings around fan back panel insert.

Remove nuts from studs around inner periphery and break seal around the edge.

Using two handles, pull fan assembly forward onto base of oven.

Remove wires from fan motor terminals, previously noting location of numbered wires and withdraw assembly clear of the oven.

Dismantle inner fan from shaft by removing centre fixing screw and pulling fan off.

Remove motor by undoing 4 slotted screws (1 per leg of spider mounting).

Re-fit replacement motor in reverse order. Ensure mounting plate is properly resealed using a high temperature, food contact safe sealant, e.g. Ambersil.

Note - Do not fit inner fan from one motor on to another. Doing so is likely to result in assembly being imbalanced, causing vibration and excessive noise.

When fitting fan to shaft, ensure pin in shaft is engaged in mating slot in fan boss.

3.13 CAPACITOR.

Warning: Always ensure that capacitor is safely discharged before handling.

To replace, proceed as follows:

Remove RH side panel (as Section 3.2.5).

Disconnect capacitor connections at terminal block mounted on panel, first noting the positions.

Remove hex nut at rear of capacitor and remove capacitor.

Replace in reverse order.

3.14 BUZZER

To replace, proceed as follows:

Withdraw oven control panel (as Section 3.2.1) and undo fixings for burner chamber grille.

Undo floor bracket fixing.

Remove buzzer fixing to bracket and disconnect electrical connections.

Replace in reverse order.

3.15 NEONS

Open oven control panel as detailed in Section 3.2.1.

Disconnect wiring and fixing nut.

Withdraw neon forwards.

Replace in reverse order.

3.16 OVEN LIGHT PUSH BUTTON

Open oven control panel as detailed in Section 3.2.1.

Remove electrical connectors at rear.

Undo fixing nut and remove.

Replace in reverse order.

3.17 OVEN THERMOSTAT

Open oven control panel as detailed in Section 3.2.1.

Pull electrical connections off at rear and control knob from front.

Undo control panel fixings.

Remove RH outer side panel from appliance as detailed in Section 3.2.5. Slacken clip(s) which retains capillary tube to inside wall of controls compartment.

Open oven doors and remove grid shelves.

Remove inner oven back and Right hand linings as detailed in section 3.2.4, thus exposing thermostat bulb.

Remove thermostat bulb from clips and slacken clip which retains capillary tube to oven wall.

Withdraw thermostat, feeding capillary tube and bulb through hole in oven wall.

Replace in reverse order, taking care to replace insulating sleeving on the capillary tube, and to coil excess tubing out of the way of live parts.

Note

Re-calibration of thermostat requires use of a special tool, and therefore, cannot be undertaken other than by qualified personnel.

3.18 POWER SWITCH

Open oven control panel as detailed in Section 3.2.1.

Pull off rear connections. Compress plastic securing tabs, enabling switch to be withdrawn from front.

To replace, simply push switch into hole, ensuring it is the correct way up. The locating tabs automatically spring into position.

3.19 TIMER

Open oven control panel as detailed in Section 3.2.1.

Remove push-on connections at rear. Pull off control knob and undo fixings holding timer to panel.

Replace in reverse order.

3.20 OVEN FUSE

Open oven control panel as detailed in Section 3.2.1.

The fuse is located upon oven control panel side tray.

Lift off cover to replace fuse.

To replace fuse holder, RH side panel must be removed as detailed in Section 3.2.5.

Remove fuse and undo centre fixing.

3.21 OVEN DOOR SEAL

Seal is fixed to door frame with special spring clips. To remove, simply ease clips from holes.

Replacement seals are supplied with clips fixed to seal ready for insertion in holes in frame. Seal ends are inserted into large holes at door frame corners. After fitting replacement seal, check it closes effectively at all points, although minor gaps and cracks can be tolerated without affecting performance. If necessary, door fit and roller catch can be adjusted by removal or addition of shims under hinge brackets and roller catch keeper plate.

Adjust shims as necessary to produce necessary fit, endeavouring to achieve all-round seal contact.

The roller catch keeper is adjusted by adding or removing shims so the doors are held positively closed with roller exerting a slight pressure tending to close them. Also check when oven is hot.

Shims have slotted holes, therefore it is only necessary to slacken respective fixings in order to remove or replace them.

3.22 SAFETY THERMOSTAT REMOVAL

Open oven control panel as detailed in Section 3.2.1.

Remove RH outer side panel from appliance as detailed in Section 3.2.5.

Pull electrical connections off thermostat.

Slacken clip(s) which retain capillary tube to inside wall of controls compartment.

Undo nut which holds safety stat body to bracket and remove from bracket.

Open oven doors and remove grid shelves.

Remove inner oven back and right hand linings as detailed in section 3.2.4, thus exposing thermostat bulb.

Remove thermostat bulb from bracket and slacken clip which retains capillary tube to oven wall.

Withdraw thermostat, feeding capillary tube and bulb through hole in oven wall.

Replace in reverse order, taking care to replace insulating sleeve on the capillary tube, and to coil excess tubing out of the way of live parts.

SECTION 4 – SPARES

When ordering any spare parts always quote the appliance type and serial number. This information will be found on the data plate attached to the oven front frame at the side of the oven control compartment or on data plate at rear of appliance.

Short Spares List

- Pan support
- Control knob for hob burner control
- Control knob for oven control
- Control knob for timer
- Door catch
- Oven shelf
- Burner cap
- Burner base
- Injector holder c/w injector (Boost – Natural gas)
- Boost injector - Open Top (Natural gas)
- Boost injector – Open Top (Propane)
- Open top thermocouple (Short)
- Open top thermocouple (Long)
- Governor (Natural gas)
- Burner control for open top
- Low position setting screw (Natural gas)
- Low position setting screw (Propane)
- Oven burner
- Oven injector (Natural gas)
- Oven injector (Propane)
- Multifunctional gas control valve
- Oven burner electrode
- Oven pilot assembly
- Pilot injector (Natural gas)
- Pilot injector (Propane)
- Oven thermocouple
- Oven fan
- Fan capacitor
- Oven lamp
- Lamp holder
- Oven lamp lens
- 2 Amp fuse
- Buzzer
- Piezo igniter
- Timer
- Oven light switch
- Power switch
- Red neon
- Amber neon
- Oven thermostat
- Oven safety thermostat
- Door micro-switch
- Oven door seal kit
- Door catch

Oven Wiring Diagram

